

# 3D Placement with Macros

Kai-Shun Hu, Hao-Yu Chi, I-Jye Lin, Yi-Hsuan Wu, Wei-Hsu Chen, and Yi-Ting Hsieh

Synopsys, Inc.

## 0. Revise History

Feb/10 – first version

## 1. Introduction

In the chiplet era, we see the benefit by splitting a large die into two or more small dies. By having small chiplet dies with die-to-die connections, we expect to get 1) better yield, 2) better performance, 3) better cost (each die can be fabricated by different technologies) & 4) faster time-to-market.

Fig. 1 showed an example of partitioning a netlist into 2 smaller dies. The interconnections between 2 smaller dies need to be physically connected to complete the logic of the original netlist.

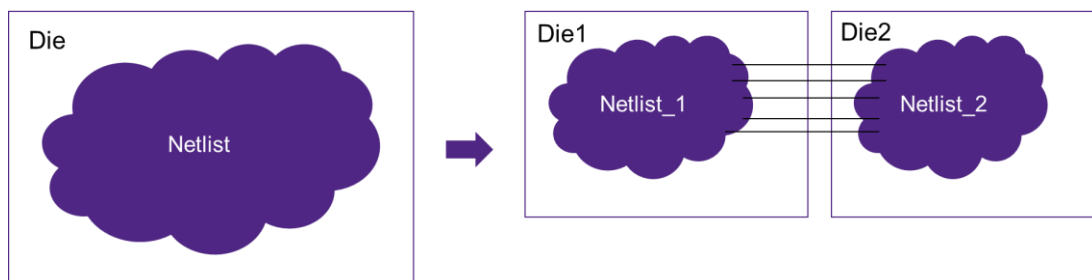

Fig. 1, netlist partitioning

In the 2022 CAD Contest in ICCAD [1], we had provided the 3D placement problem with the scope of std cells only designs. In this 2023 contest, we want to explore the new innovative ideas on the 3D placement problem for the design with std cells and macros together. With macros involved, the problem would be much different than the 2022 contest.

We will focus on 2-die face-to-face vertically stacked configuration. The 2 dies will have the same die size. As it is face-to-face connected, the inter-die connection terminals will be on the top-most layer for both dies. Thus, the inter-die connections would not occupy any placement resource on both dies. In the fabrication, the inter-die connections can be realized with hybrid bonding technology.

Fig. 2 showed an example of 2-die face-to-face vertically connected with hybrid bonding technology. The top die will be flipped to be face down connected to the bottom die in the fabrication process.

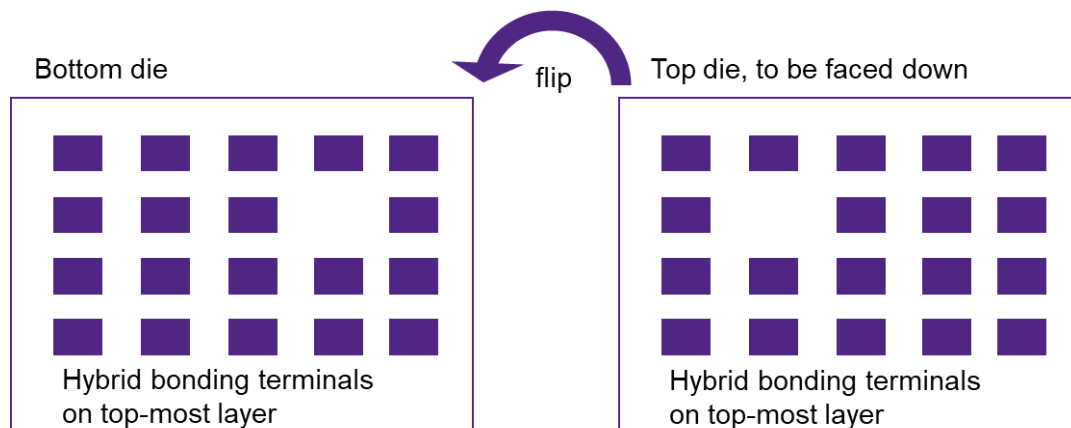

Fig. 2, face-to-face vertically connected with hybrid bonding terminals

As the pitch of hybrid bonding terminals is much larger than the std cell size, the total number of hybrid bonding terminals is limited. That is because all the hybrid bonding terminals need to be placed on the top-most layer of the die with required terminal size and terminal spacing requirement.

Each of the chiplet dies can be implemented with different technologies to achieve cost reduction. With different technologies, the cell characteristic, cell height, cell size, cell pin locations would be different.

In this context, we will focus on 2-die face-to-face configuration with either the same or different technology process on 2 dies to achieve following:

1. Partition the given netlist into 2 dies with the given placement utilization constraints of 2 dies.
2. The inter-die connections need to have 1 and only 1 hybrid bonding terminal on the top-most layer of the 2 dies that satisfied the given terminal size and spacing constraint.
3. After partitioning the given netlist into 2 dies, contestants need to place the macros and legalize std cells for top die and bottom die respectively. The technology process of the 2 dies will be given. If the 2 dies are given with different technologies, both given technologies would have the same logical library cells by library cell name matching. However, the stdCell/macro size, height, & stdCell/macro pin location of the same logical cell would be different in each technology.
4. Goal is to optimize the given score metrics which include 1) total Half-Perimeter Wirelength (HPWL) of the 2 placed dies, 2) hybrid bonding terminal cost, & 3) runtime cost. The center point of the hybrid bonding terminals needs to be included in the HPWL calculation for each die.

## 2. Contest Objective

The contestants need to develop a 3D placer engine to place and optimize the 2 dies macro & std cell and have the hybrid bonding terminal placement to minimize the total HPWL of the 2 dies along with taking the hybrid bonding terminal cost and the runtime cost into consideration as well. Macros can be placed at any location as long as the placed macro is not overlapping with other macros or std cells. All the std cells need to be placed on row and cannot have overlap with other std cells or macros. All the std cells would be with single row height of the corresponding technology of the die. All the macros will always be with rectangle shape. Also, all the given constraints need to be satisfied.

## 3. Problem formulation, Input/Output Format

Given:

1. Netlist
2. Die size for both bottom die and top die
  - It would be the same size for both dies
3. Max placement utilization ratio for top die
4. Max placement utilization ratio for bottom die
5. Placement rows of top die
6. Placement rows of bottom die
7. Macro & std cell library for each die. If the 2 dies are with different technologies, the given macro & std cell library for each die would have equivalent logic
8. Hybrid bonding terminal size & the required spacing between 2 terminals and between terminal and die boundary
9. Hybrid bonding terminal cost

Output:

1. Top die placement result
2. Bottom die placement result
3. Hybrid bonding terminal placement result with net information

All the output, including placement result and hybrid bonding terminal locations are with the resolution of integer.

For the std cells, it cannot be rotated nor mirrored. That means only the orientation of "R0" is allowed in the output.

For the macros, macro cell rotation is allowed but NOT mirroring. it can be rotated with 0, 90, 180, & 270 degrees (counterclockwise). However, mirroring is not allowed. That means, for macros, the orientation of "R0", "R90", "R180", & "R270" are allowed in the output.

For the output, please use the same coordinate system for both top die and bottom die. That means the bottom-left point of top die and bottom die are both at (0, 0). In the output file, the same (x, y) coordinate on 2 dies would mean the same physical location on the surface. So, the same (x, y) coordinate of the hybrid bonding terminal on top die and bottom die would mean the hybrid bonding terminal would touch each other to complete the physical connection.

The fabrication process can be illustrated as in Fig 3. We firstly use the same coordinate system to generate the output. Then, the layout of the top die would be mirrored by Y-axis for getting the finalized layout for fabrication. But, in this contest, we do NOT need to consider the Y-mirrored process for top die. What needed to be outputted in this contest is (3.A).

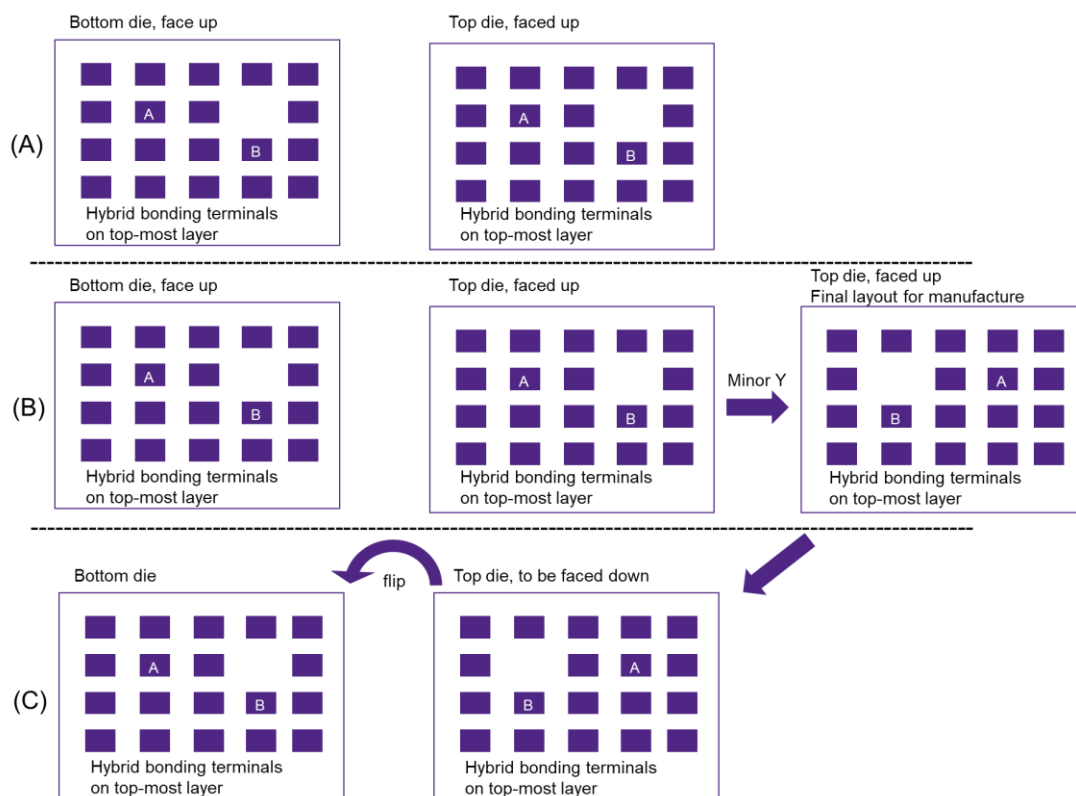

Fig. 3, three steps of preparing the final layout for fabrication. (3.A) the output for this contest. (3.B) the layout of top die would be mirrored by Y-axis. (3.C) would ship the top die Y-mirrored layout for fabrication.

### 3.1 Format of Input data

#### Netlist

##### *Syntax*

```
NumInstances <instanceCount>
Inst <instName> <libCellName>
NumNets <netCount>
Net <netName> <numPins>
Pin <instName>/<libPinName>
```

##### *Example*

```
NumInstances 2
Inst C1 MC1
Inst C2 MC3
NumNets 1
Net N1 2
Pin C1/P2
Pin C2/P1
```

#### Die size for both the bottom die and top die

##### *Syntax*

```
DieSize <lowerLeftX> <lowerLeftY> <upperRightX> <upperRightY>
```

##### *Example*

```
DieSize 0 0 500 450
```

Max placement utilization ratio for top die & the ratio for bottom die. The value is the max utilization percentage.

##### *Syntax*

```
TopDieMaxUtil <util>
BottomDieMaxUtil <util>
```

##### *Example*

```
TopDieMaxUtil 75
BottomDieMaxUtil 80
```

The formulation of utilization ratio of a die =

$$\frac{\sum(\text{area of each cells on the die})}{\text{Area of the die}}$$

Placement rows of top die & of bottom die. The given rows would start from (0, 0) and cover the entire die.

**Syntax**

```
TopDieRows <startX> <startY> <rowLength> <rowHeight> <repeatCount>  
BottomDieRows <startX> <startY> <rowLength> <rowHeight> <repeatCount>
```

**Example**

```
TopDieRows 0 0 500 10 45  
BottomDieRows 0 0 500 15 30
```

Technology and corresponding macro & std cell library. All the std cells would be with single row-height. Macros would always be with rectangle.

**Syntax**

```
NumTechnologies <technologyCount>  
Tech <techName> <libCellCount>  
LibCell <isMacro> <libCellName> <libCellSizeX> <libCellSizeY> <pinCount>  
Pin <pinName> <pinLocationX> <pinLocationY>
```

**Example**

```
NumTechnologies 2  
Tech TA 2  
LibCell N MC1 5 10 1  
Pin P1 2 7  
LibCell Y MC2 7 10 2  
Pin P1 5 3  
Pin P2 3 6  
Tech TB 2  
LibCell N MC1 5 15 1  
Pin P1 2 11  
LibCell Y MC2 7 15 2  
Pin P1 2 12  
Pin P2 3 3
```

The technology for top die and bottom die.

**Syntax**

```
TopDieTech <TechName>  
BottomDieTech <TechName>
```

**Example**

```
TopDieTech TA  
BottomDieTech TB
```

Hybrid bonding terminal size & required spacing between 2 terminals and between terminal and die boundary. And the hybrid bonding terminal cost.

***Syntax***

```
TerminalSize <sizeX> <sizeY>
```

```
TerminalSpacing <spacing>
```

```
TerminalCost <val>
```

***Example***

```
TerminalSize 20 20
```

```
TerminalSpacing 15
```

```
TerminalCost 40
```

Input file would always be with this following keyword sequence.

```
NumTechnologies
```

```
...
```

```
DieSize
```

```
TopDieMaxUtil
```

```
BottomDieMaxUtil
```

```
TopDieRows
```

```
BottomDieRows
```

```
TopDieTech
```

```
BottomDieTech
```

```
TerminalSize
```

```
TerminalSpacing
```

```
TerminalCost
```

```
NumInstances
```

```
...
```

```
NumNets
```

```
...
```

### 3.2 format of Output data

Top die placement result. The outputted coordinate is lower-left coordinate of the cell. For std cells, only orientation of "R0" is allowed. For macros, the orientation can be "R0", "R90", "R180", and "R270".

#### *Syntax*

```
TopDiePlacement <InstCount>  
Inst <instName> <locationX> <locationY> <orientation>
```

#### *Example*

```
TopDiePlacement 2  
Inst C1 0 10 R0  
Inst C4 15 20 R90
```

Bottom die placement result. The outputted coordinate is lower-left coordinate of the cell. For std cells, only orientation of "R0" is allowed. For macros, the orientation can be "R0", "R90", "R180", and "R270".

#### *Syntax*

```
BottomDiePlacement <InstCount>  
Inst <instName> <locationX> <locationY>
```

#### *Example*

```
BottomDiePlacement 3  
Inst C2 20 15 R0  
Inst C3 23 30 R180  
Inst C5 50 15 R0
```

Hybrid bonding terminal placement result with net information. The outputted terminal (x, y) location is the center of the hybrid bonding terminal.

#### *Syntax*

```
NumTerminals <TerminalCount>  
Terminal <netName> <locationX> <locationY>
```

#### *Example*

```
NumTerminals 2  
Terminal N1 100 200  
Terminal N3 180 180
```



Output file needs to be with this following keyword sequence.

```

TopDiePlacement
...
BottomDiePlacement
...
NumTerminals
...

```

## 4. Example

Example given netlist:

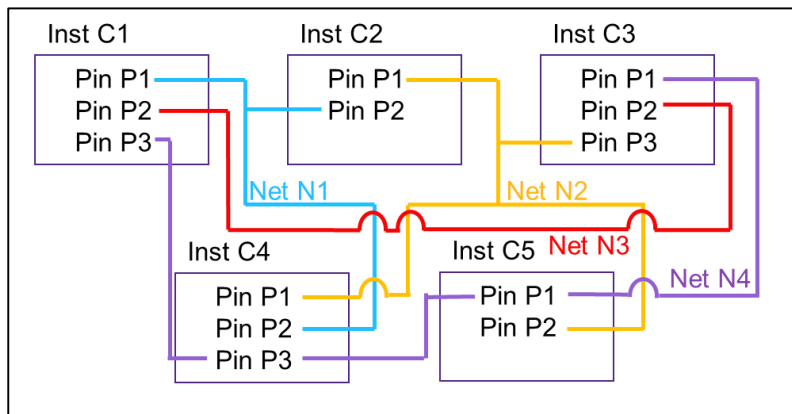

Example output:

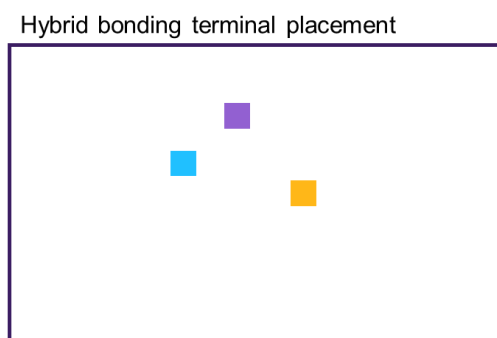
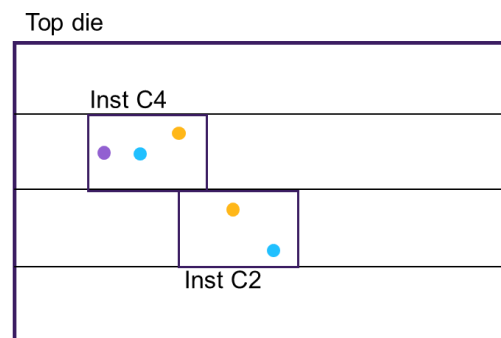
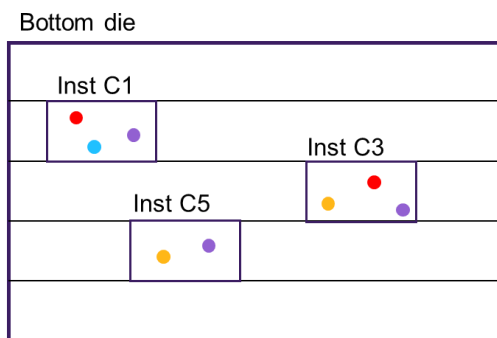

- Net N1
- Net N2
- Net N3
- Net N4

HPWL result of the output example:

Bottom die

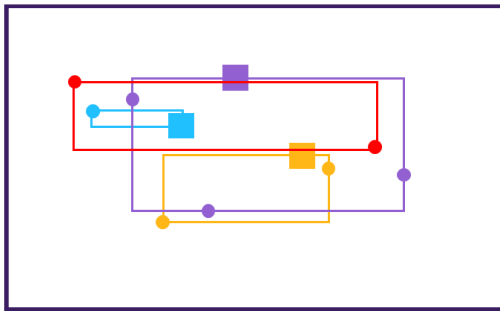

Top die

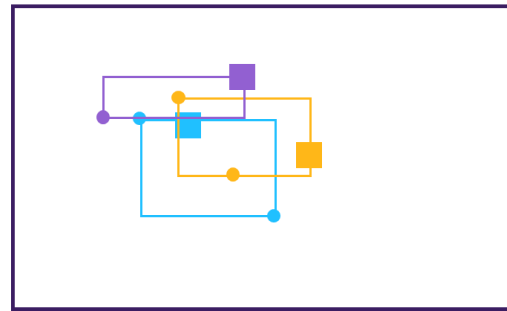

Another example for the design with macros.

Bottom die

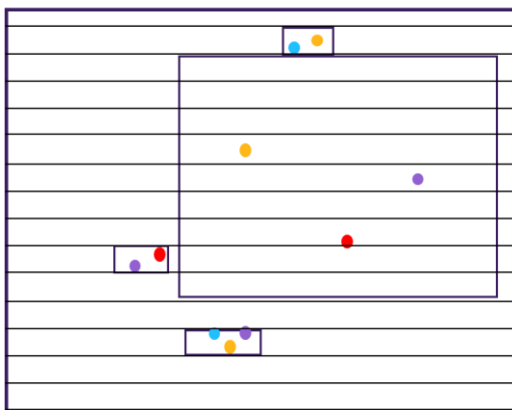

Top die

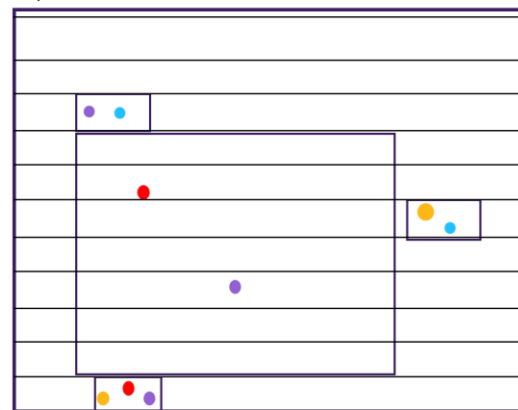

## 5. Evaluation

- Max placement utilization constraint must be satisfied
- All the given instances must be placed on either top die or bottom die
- All the instances must be without overlap & std cells must be on row
- Hybrid bonding terminal spacing constraint must be satisfied
- Crossing-die nets must have 1 and only 1 hybrid bonding terminal
- The minimum resolution of all the coordinate values is integer

If the program and the output data violate any of these above bullets, you will get 0 score for the corresponding test case.

$$\text{Initial score} = \text{HPWL of top die} + \text{HPWL of bottom die} + \# \text{terminals} \\ \times \text{terminal cost}$$

### 5.1 Runtime factor

Runtime limit is 90mins for each case in the evaluation machine. The hidden cases will be in the same scale as public cases. We would like to introduce the runtime factor in this contest as formulated below to encourage the ideas with faster turnaround-time.

The number of CPU cores available for your program is 8 cores in the evaluation.

$$\text{runtime factor} = 0.02 \times \log_2\left(\frac{\text{elapsed time of test binary}}{\text{median elapsed time}}\right)$$

$$\text{runtime factor bounded} = \max(-0.1, \min(0.1, \text{runtime factor}))$$

$$\text{Final score} = \text{Initial score} \times (1.0 + \text{runtime factor bounded})$$

With this proposed runtime factor, that means if the binary is 2x faster/slower, it would get 2% of initial score advantage/disadvantage. If the binary is 4x faster/slower, it would get 4% of initial score advantage/disadvantage. The runtime factor is bounded to 10%.

## 5.2 Program requirements

Your program should be able execute like following:

```
./$binary_name <input.txt> <output.txt>
```

## 5.3 Evaluator

There will be an Evaluator provided in the contest website. Contestants can use this provided Evaluator to validate output file format and also the correctness of the result.

```
./evaluator <input.txt> <output.txt>
```

## 6. References

[1] Kai-Shun Hu, I-Jye Lin, Yu-Hui Huang, Hao-Yu Chi, Yi-Hsuan Wu, and Chin-Fang Cindy Shen. 2022. 2022 ICCAD CAD Contest Problem B: 3D Placement with D2D Vertical Connections. In Proceedings of the 41st IEEE/ACM International Conference on Computer-Aided Design (ICCAD '22).

[2] J. Kim et al., "RTL-to-GDS Design Tools for Monolithic 3D ICs," 2020 IEEE/ACM International Conference On Computer Aided Design (ICCAD), 2020, pp. 1-8.

[3] S. S. Kiran Pentapati, K. Chang, V. Gerousis, R. Sengupta and S. K. Lim, "Pin-3D: A Physical Synthesis and Post-Layout Optimization Flow for Heterogeneous Monolithic 3D ICs," 2020 IEEE/ACM International Conference On Computer Aided Design (ICCAD), 2020, pp. 1-9.

[4] B. W. Ku, K. Chang and S. K. Lim, "Compact-2D: A Physical Design Methodology to Build Two-Tier Gate-Level 3-D ICs," in IEEE Transactions on Computer-Aided Design of Integrated Circuits and Systems, vol. 39, no. 6, pp. 1151-1164, June 2020, doi: 10.1109/TCAD.2019.2952542.